

# VECO-2000-Isotherm

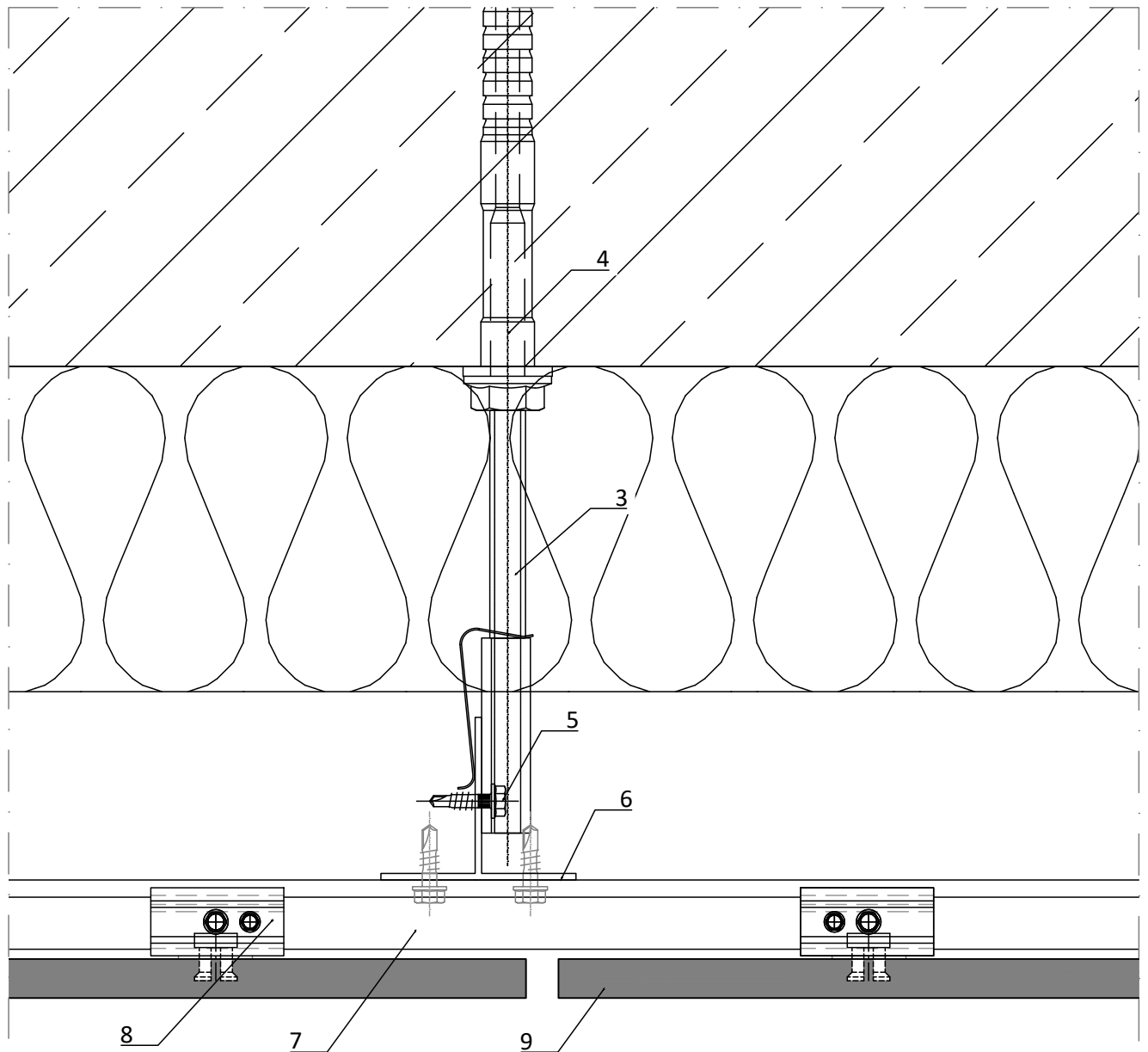

- |  |  |
|--|--|
| <p><b>1</b> Flügelwandhalter Festpunkt<br/><i>wing-holder fixing point</i></p> <p><b>2</b> Flügelwandhalter Gleitpunkt<br/><i>wing-holder slide point</i></p> <p><b>3</b> Isotherm<br/><i>Isotherm</i></p> <p><b>4</b> Verankerung mit Injektionsmörtel<br/><i>anchoring with mortar</i></p> <p><b>5</b> Bohrschraube<br/><i>self drilling screw</i></p> | <p><b>6</b> Vertikales Tragprofil (T- oder L-Profil)<br/><i>vertical profile (T- or L-profile)</i></p> <p><b>7</b> Horizontalprofile<br/><i>horizontal profiles</i></p> <p><b>8</b> Agraffen(justierbar/starr)<br/><i>agraffe(adjustable/rigid)</i></p> <p><b>9</b> Fassadenbekleidung<br/><i>cladding</i></p> |
|--|--|

VECO-2000-Isotherm.dwg

## GIP<sup>!</sup> Fassade

GIP GmbH  
Friedrich-Seele-Straße 1b  
38122 Braunschweig

Tel: 0531 - 2090 04-0  
Fax: 0531 - 2090 04-10  
www.gip-fassade.com

Unterkonstruktions-System | Substructure system

**VECO-2000-Isotherm**

Vertikale Unterkonstruktion mit T- und L-Profil  
Vertical substructure with T and L profile

Planbezeichnung | Description

Prinzipdetail | General detail  
Horizontalschnitt | horizontal section

Index	Datum	Name	Änderung
gezeichnet   drawn		Erstelldatum   date	
GIP		05/2022	
Plan-Nr.   drawing no.	Index   Rev.	MSt   Scale	
VECO-2000-IT-D-002	00	1:2	

# VECO-2000-Isotherm

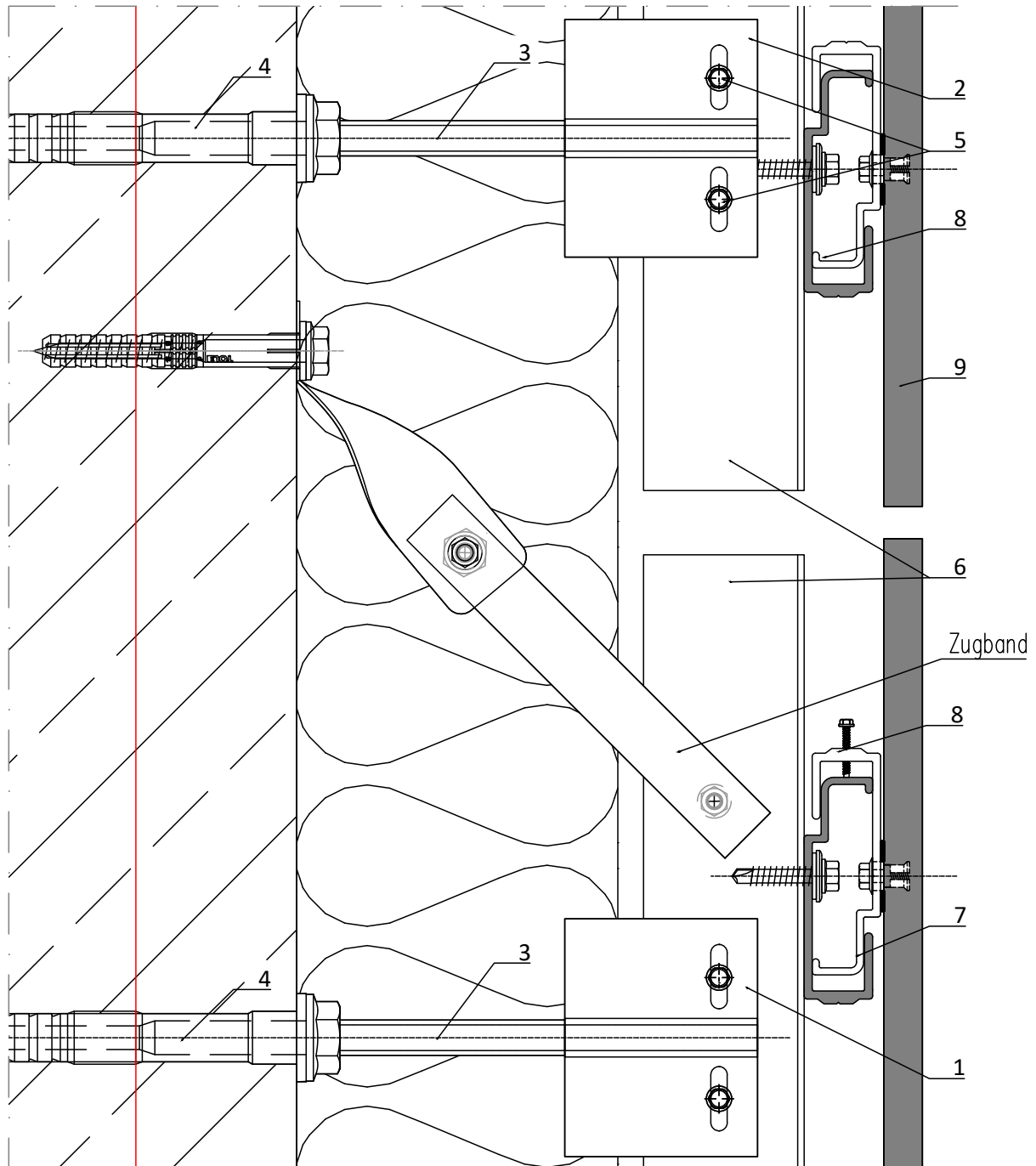

- |   |  |   |   |
|---|--|---|---|
| 1 | Flügelwandhalter Festpunkt<br><i>wing-holder fixing point</i>    | 6 | Vertikales Tragprofil (T- oder L-Profil)<br><i>vertical profile (T- or L-profile)</i> |
| 2 | Flügelwandhalter Gleitpunkt<br><i>wing-holder slide point</i>    | 7 | Horizontalprofile<br><i>horizontal profiles</i>                                       |
| 3 | Isotherm<br><i>Isotherm</i>                                      | 8 | Agraffen(justierbar/starr)<br><i>agraffe(adjustable/rigid)</i>                        |
| 4 | Verankerung mit Injektionsmörtel<br><i>anchoring with mortar</i> | 9 | Fassadenbekleidung<br><i>cladding</i>   |
| 5 | Bohrschraube<br><i>self drilling screw</i>                       |   |   |

VECO-2000-Isotherm.dwg

# GIP<sup>!</sup> Fassade

GIP GmbH  
Friedrich-Seele-Straße 1b  
38122 Braunschweig

Tel: 0531 - 2090 04-0  
Fax: 0531 - 2090 04-10  
www.gip-fassade.com

Unterkonstruktions-System | Substructure system

**VECO-2000-Isotherm**

Vertikale Unterkonstruktion mit T- und L-Profil für großformatige Platten  
Vertical substructure with T and L profile for large-format panels

Planbezeichnung | Description

Prinzipdetail | General detail  
Vertikalschnitt | vertical section

Index	Datum	Name	Änderung
gezeichnet   drawn	GIP		Erstelldatum   date
			05/2022
Plan-Nr.   drawing no.	Index   Rev.	MSt   Scale	
VECO-2000-IT-D-003	00	1:2	

# VECO-2000-Isotherm

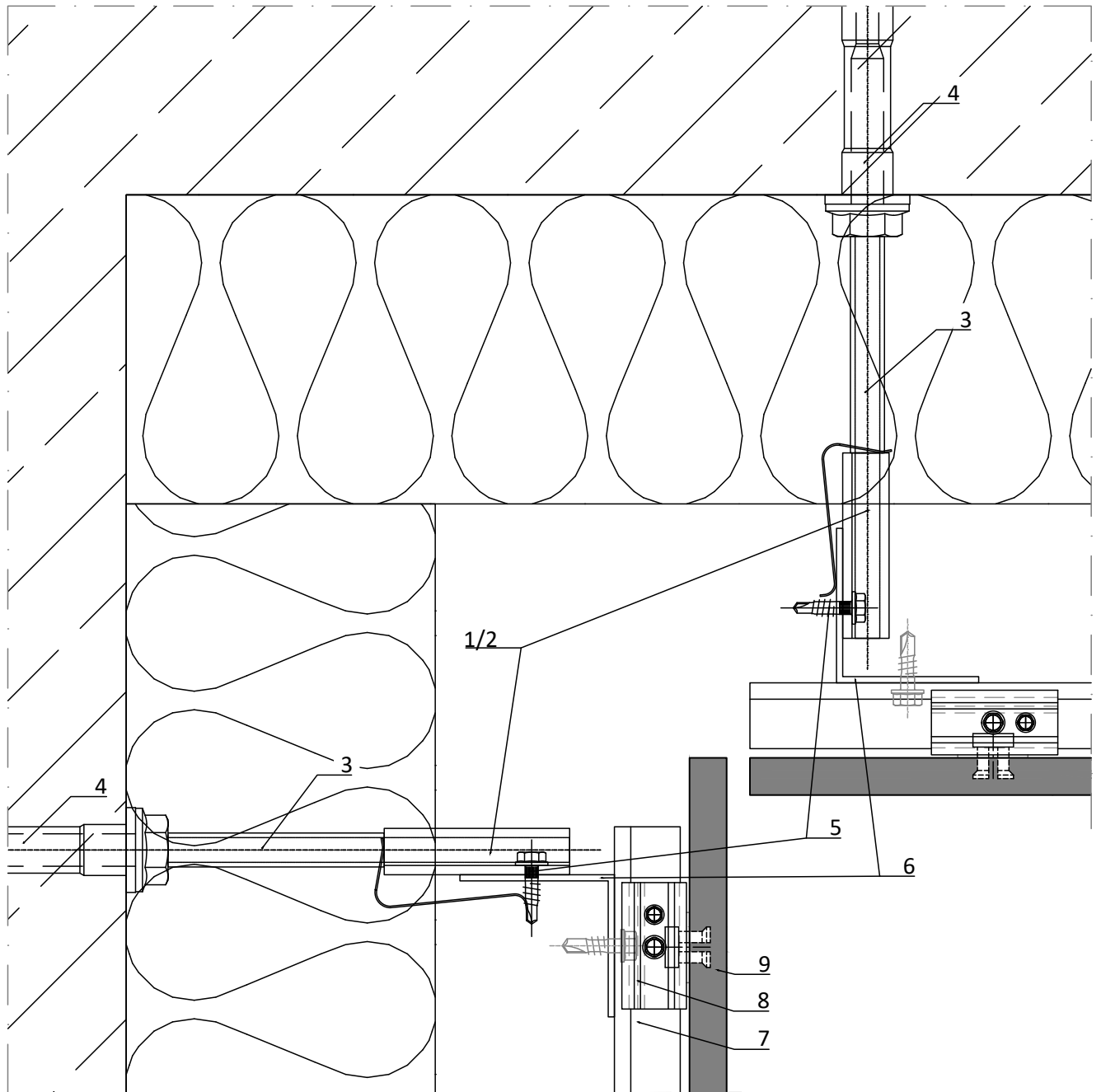

- |   |  |
|---|--|
| <p>1 Flügelwandhalter Festpunkt<br/><i>wing-holder fixing point</i></p> <p>2 Flügelwandhalter Gleitpunkt<br/><i>wing-holder slide point</i></p> <p>3 Isotherm<br/><i>Isotherm</i></p> <p>4 Verankerung mit Injektionsmörtel<br/><i>anchoring with mortar</i></p> <p>5 Bohrschraube<br/><i>self drilling screw</i></p> | <p>6 Vertikales Tragprofil (T- oder L-Profil)<br/><i>vertical profile (T- or L-profile)</i></p> <p>7 Horizontalprofile<br/><i>horizontal profiles</i></p> <p>8 Agraffen(justierbar/starr)<br/><i>agraffe(adjustable/rigid)</i></p> <p>9 Fassadenbekleidung<br/><i>cladding</i></p> |
|---|--|

**GIP** Fassade

GIP GmbH  
Friedrich-Seele-Straße 1b  
38122 Braunschweig

Tel: 0531 - 2090 04-0  
Fax: 0531 - 2090 04-10  
www.gip-fassade.com

Unterkonstruktions-System | Substructure system

**VECO-2000-Isotherm**

Vertikale Unterkonstruktion mit T- und L-Profil für großformatige Platten  
Vertical substructure with T and L profile for large-format panels

Planbezeichnung | Description

Prinzipdetail | General detail  
Innenecke | inside corner

Index	Datum	Name	Änderung
gezeichnet   drawn	Erstelldatum   date		
GIP	05/2022		
Plan-Nr.   drawing no.	Index   Rev.	MSt   Scale	
VECO-2000-IT-D-004	00	1:2	

# VECO-2000-Isotherm

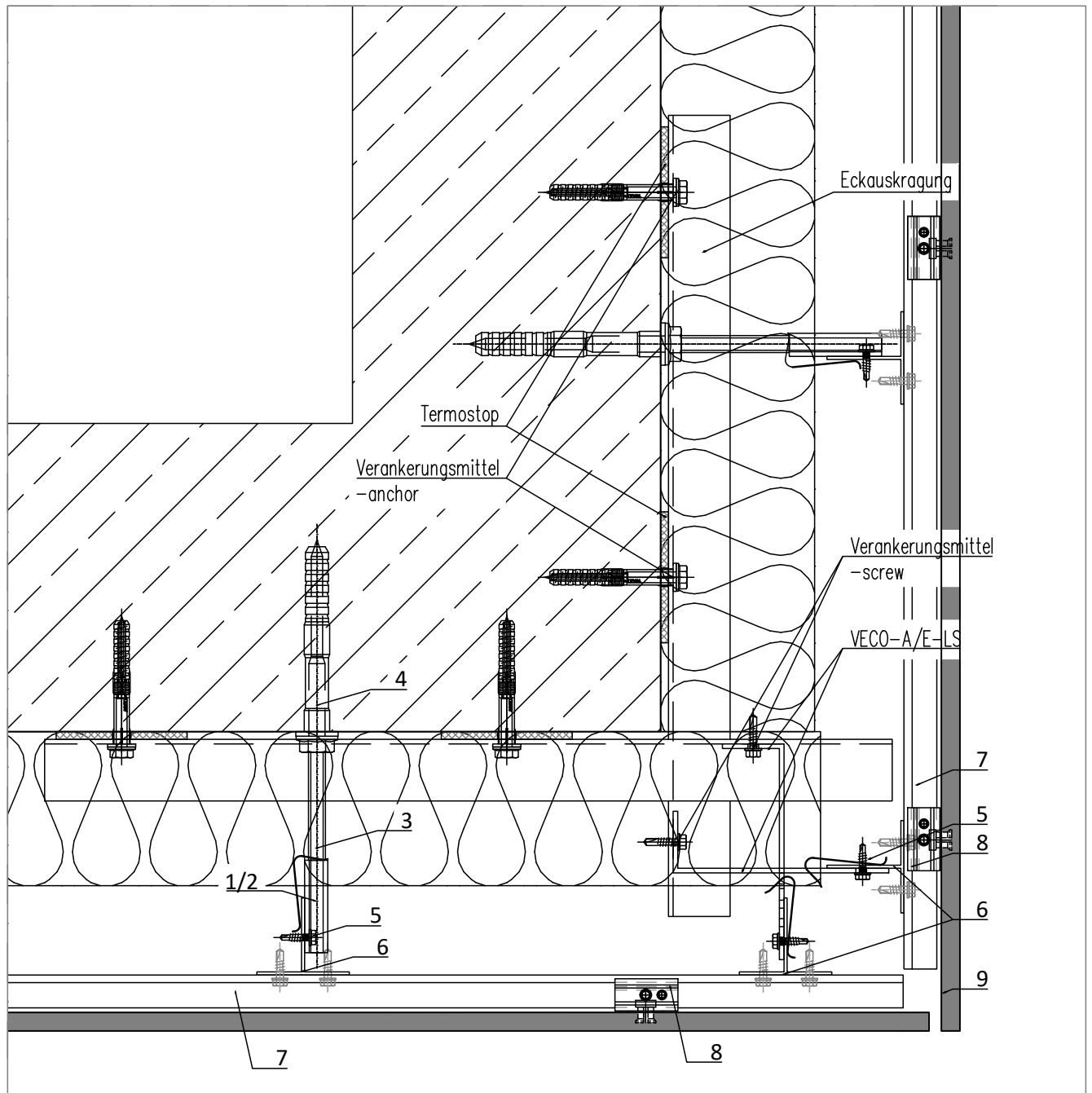

- |   |  |
|---|--|
| <p>1 Flügelwandhalter Festpunkt<br/><i>wing-holder fixing point</i></p> <p>2 Flügelwandhalter Gleitpunkt<br/><i>wing-holder slide point</i></p> <p>3 Isotherm<br/><i>Isotherm</i></p> <p>4 Verankerung mit Injektionsmörtel<br/><i>anchoring with mortar</i></p> <p>5 Bohrschraube<br/><i>self drilling screw</i></p> | <p>6 Vertikales Tragprofil (T- oder L-Profil)<br/><i>vertical profile (T- or L-profile)</i></p> <p>7 Horizontalprofile<br/><i>horizontal profiles</i></p> <p>8 Agraffen(justierbar/starr)<br/><i>agraffe(adjustable/rigid)</i></p> <p>9 Fassadenbekleidung<br/><i>cladding</i></p> |
|---|--|

**GIP<sup>1</sup>** Fassade

GIP GmbH  
Friedrich-Seele-Straße 1b  
38122 Braunschweig

Tel: 0531 - 2090 04-0  
Fax: 0531 - 2090 04-10  
www.gip-fassade.com

Unterkonstruktions-System | Substructure system

**VECO-2000-Isotherm**

Vertikale Unterkonstruktion mit T- und L-Profil für großformatige Platten  
Vertical substructure with T and L profile for large-format panels

Planbezeichnung | Description

Prinzipdetail | General detail  
Außenecke | outside corner

Index	Datum	Name	Änderung
gezeichnet   drawn	Erstelldatum   date		
GIP	05/2022		
Plan-Nr.   drawing no.	Index   Rev.	MSt   Scale	
VECO-2000-IT-D-005	00	1:4	

# VECO-2000-Isotherm

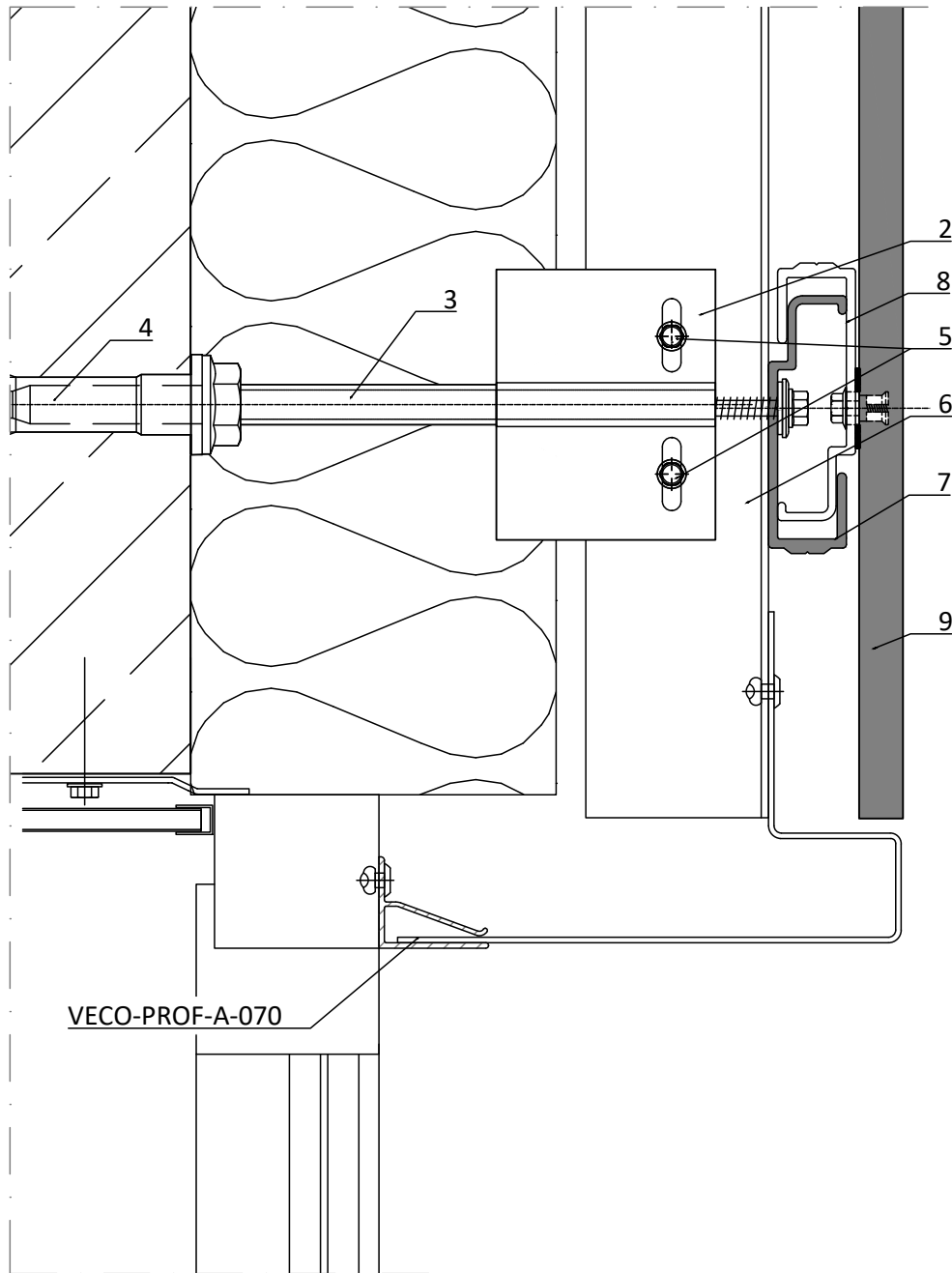

- |   |  |
|---|--|
| <p>1 Flügelwandhalter Festpunkt<br/><i>wing-holder fixing point</i></p> <p>2 Flügelwandhalter Gleitpunkt<br/><i>wing-holder slide point</i></p> <p>3 Isotherm<br/><i>Isotherm</i></p> <p>4 Verankerung mit Injektionsmörtel<br/><i>anchoring with mortar</i></p> <p>5 Bohrschraube<br/><i>self drilling screw</i></p> | <p>6 Vertikales Tragprofil (T- oder L-Profil)<br/><i>vertical profile (T- or L-profile)</i></p> <p>7 Horizontalprofile<br/><i>horizontal profiles</i></p> <p>8 Agraffen(justierbar/starr)<br/><i>agraffe(adjustable/rigid)</i></p> <p>9 Fassadenbekleidung<br/><i>cladding</i></p> |
|---|--|

VECO-2000-Isotherm.dwg

**GIP** Fassade

GIP GmbH  
Friedrich-Seele-Straße 1b  
38122 Braunschweig

Tel: 0531 - 2090 04-0  
Fax: 0531 - 2090 04-10  
www.gip-fassade.com

Unterkonstruktions-System | Substructure system

**VECO-2000-Isotherm**

Vertikale Unterkonstruktion mit T- und L-Profil für großformatige Platten  
Vertical substructure with T and L profile for large-format panels

Planbezeichnung | Description

Prinzipdetail | General detail  
Sturzausbildung | lintel detail

Index	Datum	Name	Änderung
gezeichnet   drawn		Erstelldatum   date	
GIP		05/2022	
Plan-Nr.   drawing no.		Index   Rev.	MSt   Scale
VECO-1020-IT-D-006		00	1:2

# VECO-2000-Isotherm

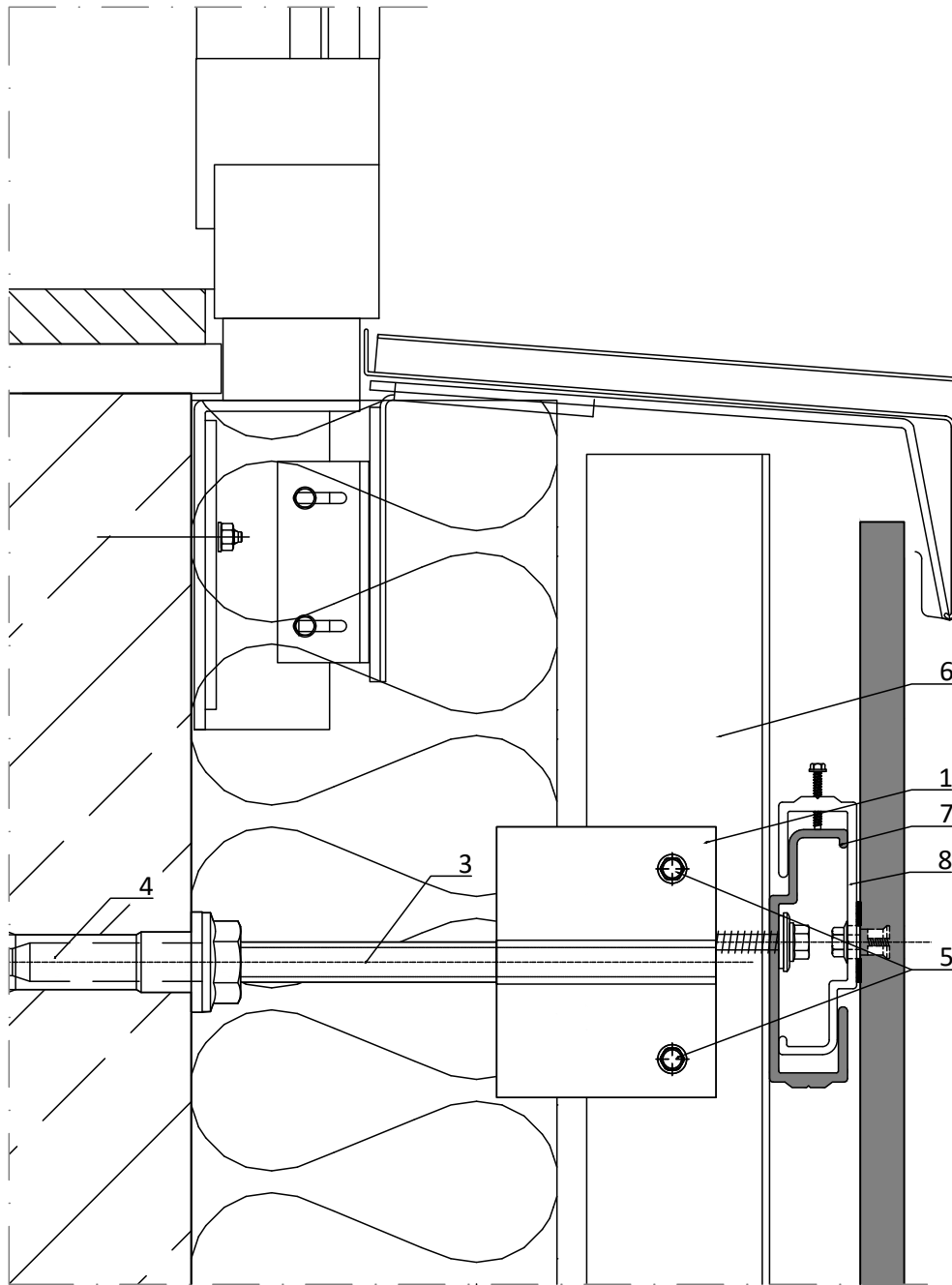

- |   |  |
|---|--|
| <p>1 Flügelwandhalter Festpunkt<br/><i>wing-holder fixing point</i></p> <p>2 Flügelwandhalter Gleitpunkt<br/><i>wing-holder slide point</i></p> <p>3 Isotherm<br/><i>Isotherm</i></p> <p>4 Verankerung mit Injektionsmörtel<br/><i>anchoring with mortar</i></p> <p>5 Bohrschraube<br/><i>self drilling screw</i></p> | <p>6 Vertikales Tragprofil (T- oder L-Profil)<br/><i>vertical profile (T- or L-profile)</i></p> <p>7 Horizontalprofile<br/><i>horizontal profiles</i></p> <p>8 Agraffen(justierbar/starr)<br/><i>agraffe(adjustable/rigid)</i></p> <p>9 Fassadenbekleidung<br/><i>cladding</i></p> |
|---|--|

**GIP** Fassade

GIP GmbH  
Friedrich-Seele-Straße 1b  
38122 Braunschweig

Tel: 0531 - 2090 04-0  
Fax: 0531 - 2090 04-10  
www.gip-fassade.com

Unterkonstruktions-System | Substructure system

**VECO-2000-Isotherm**

Vertikale Unterkonstruktion mit T- und L-Profil für großformatige Platten  
Vertical substructure with T and L profile for large-format panels

Planbezeichnung | Description

Prinzipdetail | General detail  
Brüstungsausbildung | window sill

Index	Datum	Name	Änderung
gezeichnet   drawn		Erstelldatum   date	
GIP		05/2022	
Plan-Nr.   drawing no.		Index   Rev.	MSt   Scale
VECO-2000-IT-D-007		00	1:2

# VECO-2000-Isotherm

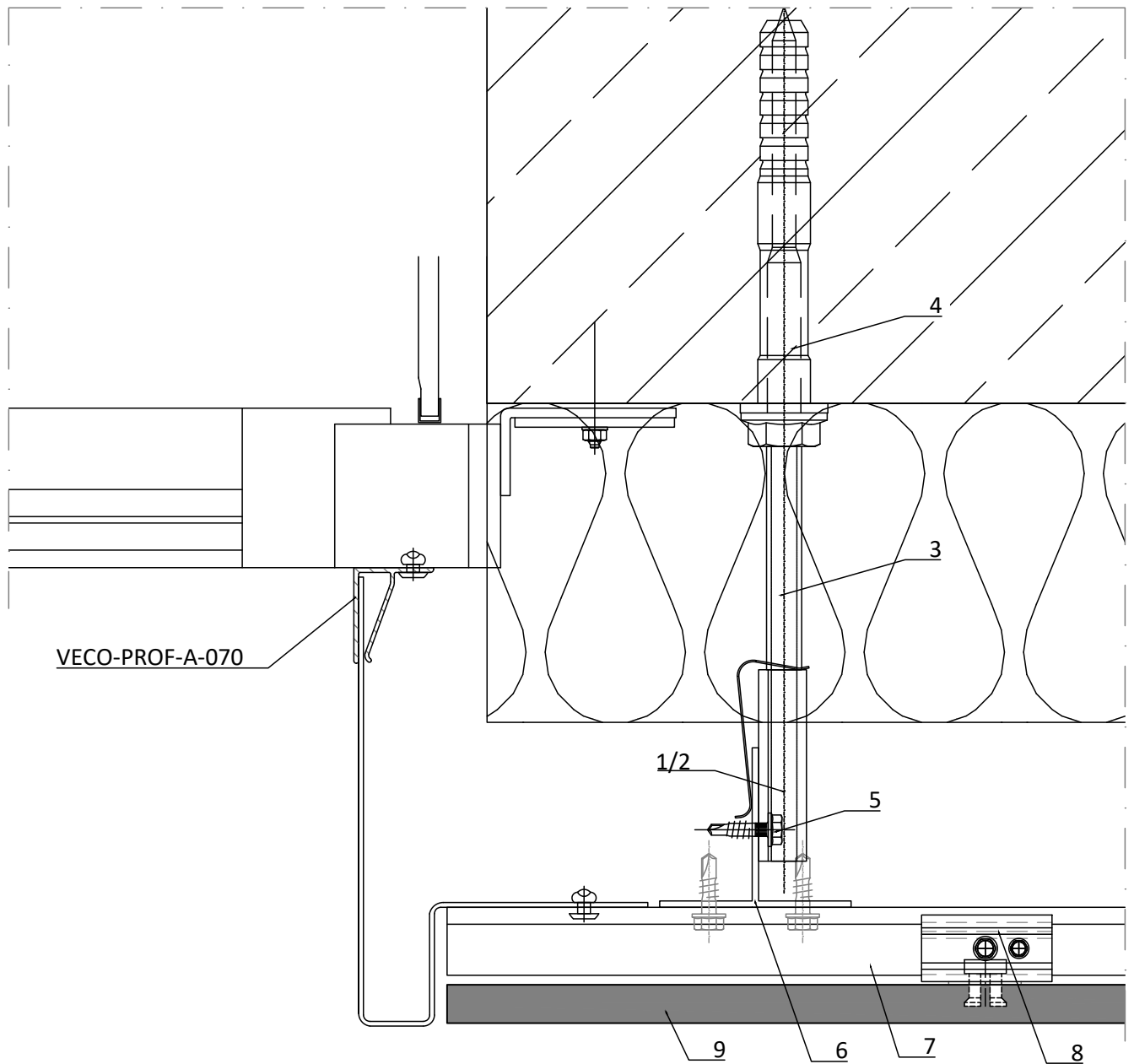

- |   |  |
|---|--|
| <p>1 Flügelwandhalter Festpunkt<br/><i>wing-holder fixing point</i></p> <p>2 Flügelwandhalter Gleitpunkt<br/><i>wing-holder slide point</i></p> <p>3 Isotherm<br/><i>Isotherm</i></p> <p>4 Verankerung mit Injektionsmörtel<br/><i>anchoring with mortar</i></p> <p>5 Bohrschraube<br/><i>self drilling screw</i></p> | <p>6 Vertikales Tragprofil (T- oder L-Profil)<br/><i>vertical profile (T- or L-profile)</i></p> <p>7 Horizontalprofile<br/><i>horizontal profiles</i></p> <p>8 Agraffen(justierbar/starr)<br/><i>agraffe(adjustable/rigid)</i></p> <p>9 Fassadenbekleidung<br/><i>cladding</i></p> |
|---|--|

**GIP** Fassade

GIP GmbH  
Friedrich-Seele-Straße 1b  
38122 Braunschweig

Tel: 0531 - 2090 04-0  
Fax: 0531 - 2090 04-10  
www.gip-fassade.com

Unterkonstruktions-System | Substructure system

**VECO-2000-Isotherm**

Vertikale Unterkonstruktion mit T- und L-Profil für großformatige Platten  
Vertical substructure with T and L profile for large-format panels

Planbezeichnung | Description

Prinzipdetail | General detail  
Laibungsbildung | reveal detail

Index	Datum	Name	Änderung
gezeichnet   drawn		Erstelldatum   date	
GIP		05/2022	
Plan-Nr.   drawing no.		Index   Rev.	MSt   Scale
VECO-2000-IT-D-008		00	1:2

# VECO-2000-Isotherm

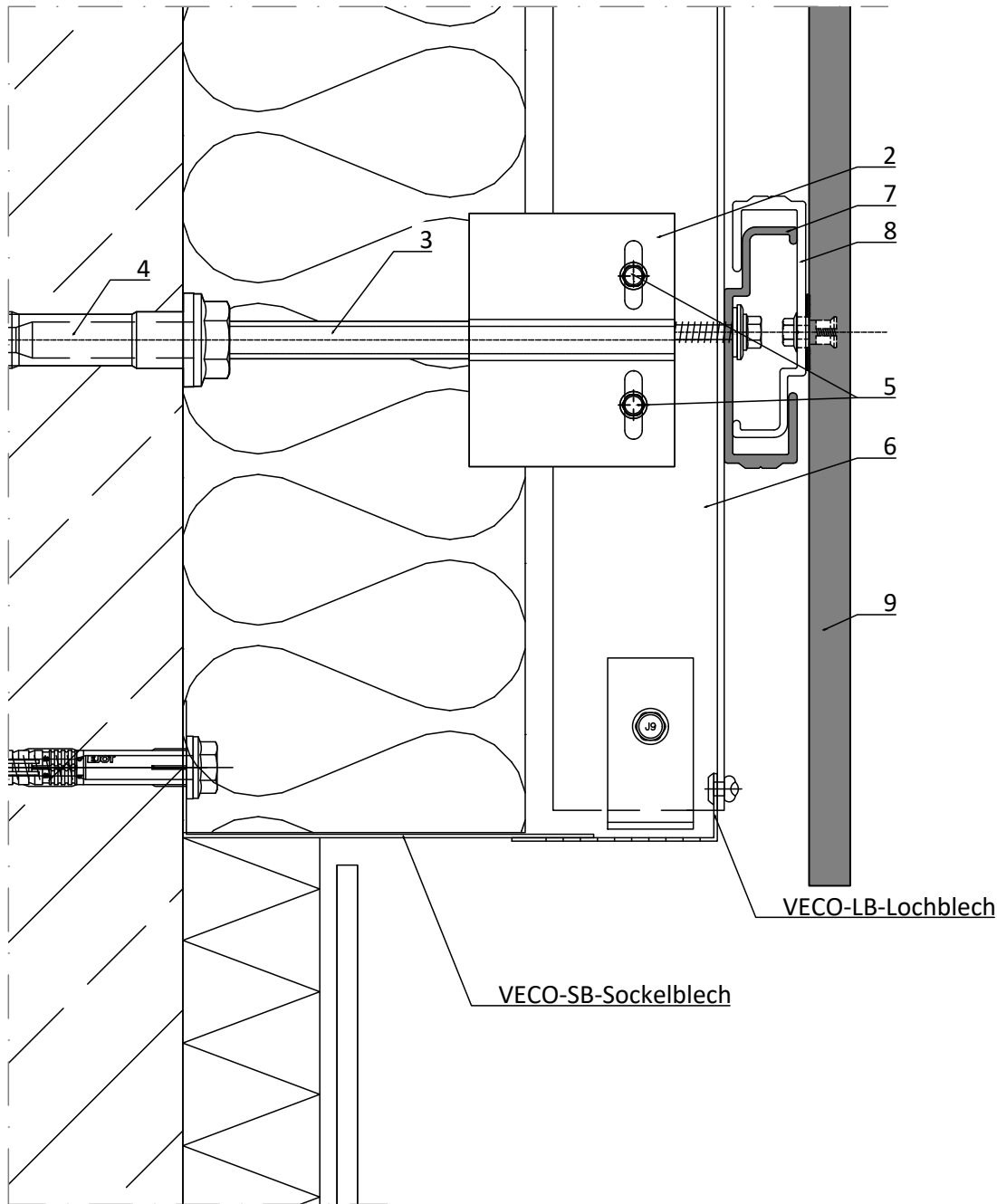

- |  |  |
|--|--|
| <p><b>1</b> Flügelwandhalter Festpunkt<br/><i>wing-holder fixing point</i></p> <p><b>2</b> Flügelwandhalter Gleitpunkt<br/><i>wing-holder slide point</i></p> <p><b>3</b> Isotherm<br/><i>Isotherm</i></p> <p><b>4</b> Verankerung mit Injektionsmörtel<br/><i>anchoring with mortar</i></p> <p><b>5</b> Bohrschraube<br/><i>self drilling screw</i></p> | <p><b>6</b> Vertikales Tragprofil (T- oder L-Profil)<br/><i>vertical profile (T- or L-profile)</i></p> <p><b>7</b> Horizontalprofile<br/><i>horizontal profiles</i></p> <p><b>8</b> Agraffen(justierbar/starr)<br/><i>agraffe(adjustable/rigid)</i></p> <p><b>9</b> Fassadenbekleidung<br/><i>cladding</i></p> |
|--|--|

Index	Datum	Name	Änderung
gezeichnet   drawn		Erstelldatum   date	
GIP		05/2022	
Plan-Nr.   drawing no.	Index   Rev.	MSt   Scale	
VECO-2000-IT-D-009	00	1:2	



# VECO-2000-Isotherm

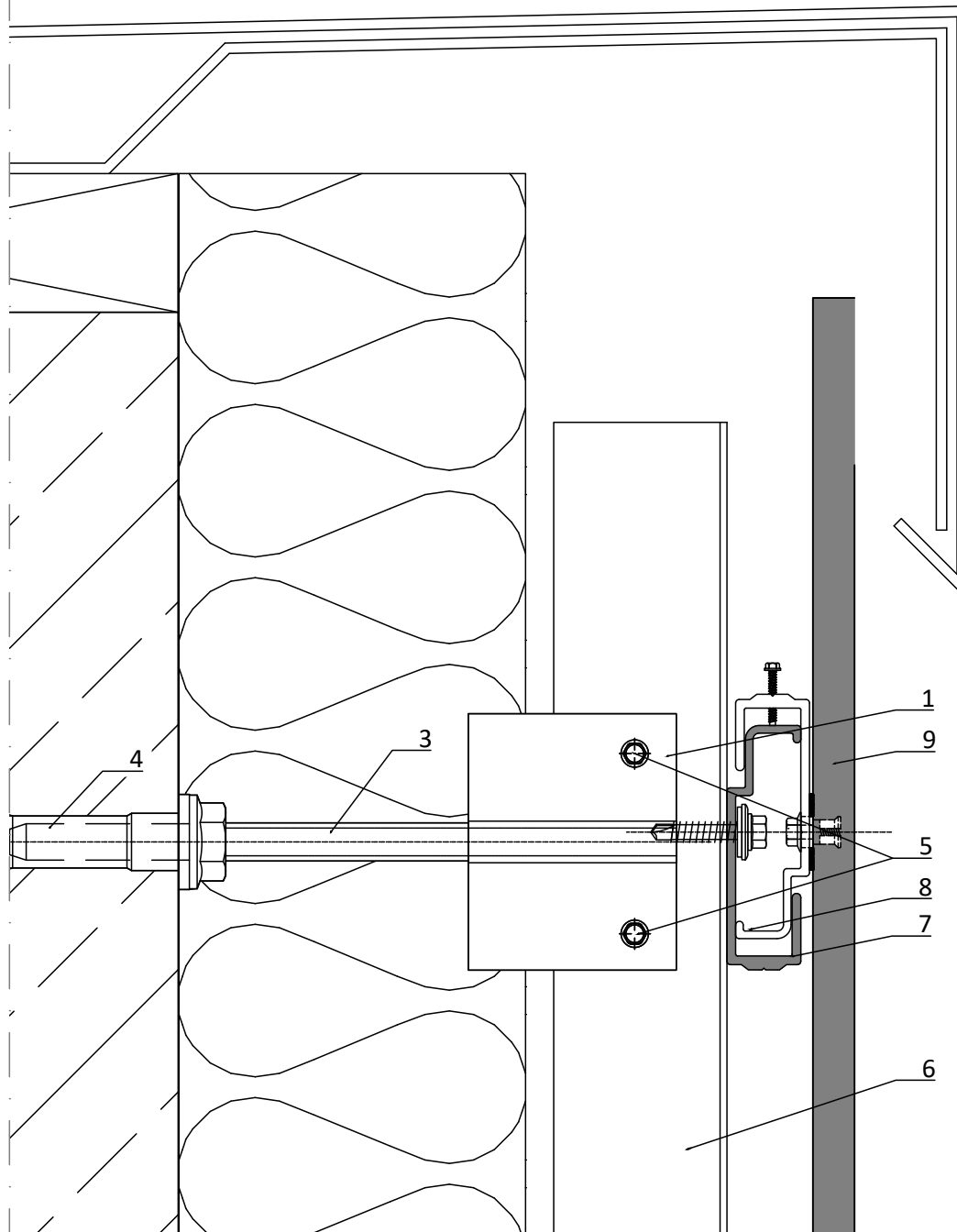

- |   |  |
|---|--|
| <p>1 Flügelwandhalter Festpunkt<br/><i>wing-holder fixing point</i></p> <p>2 Flügelwandhalter Gleitpunkt<br/><i>wing-holder slide point</i></p> <p>3 Isotherm<br/><i>Isotherm</i></p> <p>4 Verankerung mit Injektionsmörtel<br/><i>anchoring with mortar</i></p> <p>5 Bohrschraube<br/><i>self drilling screw</i></p> | <p>6 Vertikales Tragprofil (T- oder L-Profil)<br/><i>vertical profile (T- or L-profile)</i></p> <p>7 Horizontalprofile<br/><i>horizontal profiles</i></p> <p>8 Agraffen(justierbar/starr)<br/><i>agraffe(adjustable/rigid)</i></p> <p>9 Fassadenbekleidung<br/><i>cladding</i></p> |
|---|--|

**GIP** Fassade

GIP GmbH  
Friedrich-Seele-Straße 1b  
38122 Braunschweig

Tel: 0531 - 2090 04-0  
Fax: 0531 - 2090 04-10  
www.gip-fassade.com

Unterkonstruktions-System | Substructure system

**VECO-2000-Isotherm**

Vertikale Unterkonstruktion mit T- und L-Profil für großformatige Platten  
Vertical substructure with T and L profile for large-format panels

Planbezeichnung | Description

Prinzipdetail | General detail  
Attika | parapet detail

Index	Datum	Name	Änderung
gezeichnet   drawn		Erstelldatum   date	
GIP		05/2022	
Plan-Nr.   drawing no.	Index   Rev.	MSt   Scale	
VECO-2000-IT-D-010	00	1:2	

VECO-2000-Isotherm.dwg